

MUELLER®

Centurion® Series Fire Hydrant

- Centurion®
- Super Centurion 200
- Super Centurion 250

TABLE OF CONTENTS	PAGE
Background and Forward	2
Handling and Inspection	3
Installation	4
Facing the Hydrant	5
Adding an Extension	6-7
Lubrication and Maintenance	8
Restoring Service after Traffic Knockover	9-10
Main Valve Replacement: Bonnet Flange	11-12
Main Valve Replacement: Lower Barrel Flange	13-14
Replacing Damaged Nozzles	15
Changing the Shoe	16
Repainting the Hydrant	17
Parts	18
Tools	19



Reliable Connections®

Customer Service Center
Decatur, Illinois
800.423.1323
www.muellercompany.com
moreinfo@muellercompany.com

⚠ WARNING: Before working on, or disassembling the Hydrant (including removing any bolts(s) holding the Hydrant together), shut off gate valve to isolate Hydrant from main water source. Loosen (do not remove) one nozzle cap two turns and check for water under pressure inside Hydrant - bleed off any pressure, then remove nozzle cap completely. Open Hydrant main valve completely. A continuous flow of water, no matter how slight, indicates Hydrant is not properly isolated from the main water supply, and that problem must be corrected before any Hydrant disassembly can proceed. Disassembly of Hydrant with pressurized water acting against the main valve could result in unexpected ejection of Hydrant parts, debris or high-pressure water stream, which could cause serious bodily injury.

MUELLER® Centurion® Series Fire Hydrant

Background and Forward

BACKGROUND

Since its introduction in 1975, there have been 3 models of the Centurion Hydrant; **Centurion, Super Centurion 200 and Super Centurion 250.**

Centurion

The Mueller Centurion Fire Hydrant was produced between 1975 and 1986.

Super Centurion 200

The Mueller Super Centurion 200 Fire Hydrant was introduced in 1987 and replaced the Centurion Fire Hydrant. It continued in production until 1997 when the

Super Centurion 250 Fire Hydrant was introduced. Some models of the Super Centurion 200 Fire Hydrant continue in production. The Super Centurion 200 Fire Hydrant replaced the Centurion Weather Cap with a Weather Seal on the Hold-Down Nut. In 2011, the flat gasket used at the Ground Line connection was replaced by an O-ring seal.

Super Centurion 250

The Mueller Super Centurion 250 Fire Hydrant was introduced in 1997 and continues in production. The Super Centurion 250 Fire Hydrant

is pressure rated for 250psi. Key features include an O-ring seal at Bonnet and Ground Line connection, a Reversible Main Valve and a Stainless Steel Stem Coupling. The Centurion and Super Centurion 200 Fire Hydrant use 2 bolts to attach the Drain Ring Housing to the Lower Barrel. The Super Centurion 250 Fire Hydrant eliminated the bolts and uses 2 of the Barrel-to-Shoe bolts to hold the Drain Ring Housing in place.

FORWARD

This manual will apply to all 3 models. However, instructions and illustrations all refer to the O-ring seal. Please note that the Centurion and pre-2011 Super Centurion 200 Fire Hydrant will have flat gaskets; instructions referencing O-rings should be understood to refer to flat gaskets on these models.

When replacing a shoe on the Centurion and Super Centurion 200 Fire Hydrant, the 2 bolts used to attach the Drain Ring Housing are not used. The Barrel, Drain Ring Housing and Shoe attach the same way as the Super Centurion 250 Fire Hydrant.

The Stainless Steel Stem Coupling used on the Super Centurion 250

Fire Hydrant is compatible with the Centurion and Super Centurion 200 Fire Hydrant.

The Reversible Main Valve, introduced on the Super Centurion 250 Fire Hydrant can be used on the Centurion and Super Centurion 200 Fire Hydrant, but requires replacing the Lower Valve Plate.

MUELLER® Centurion® Series Fire Hydrant

Handling and Inspection



EQUIPMENT & TOOLS NEEDED – PPE: Hard hat, safety shoes, safety vest, safety glasses, work gloves.
Tools: Backhoe, lifting straps.

HANDLING

- DO NOT drop the Hydrant when unloading, because serious damage could result.
 - When handling Hydrants, always lift with a sling.
 - DO NOT drag Hydrants or roll over nozzles.
 - DO NOT use cap chains for lifting.
 - Avoid stress loads on the ground line flange.
 - Store Hydrants on blocks with the Hydrant inlet facing downward. Make sure the main valve is closed tight and the nozzle caps are in place.
 - When stocking Hydrants, separate with adequate timber blocking.
- After unloading the Hydrant, cycle to full-open and close positions to check for possible internal damage during shipment. When the main valve is open, check for damage and tightness.

INSPECTION

At the time of delivery, examine the entire shipment for shortages, breakage, external damage, etc. Note all problems on delivery ticket and have the driver acknowledge by signing all copies. Make sure Hydrant conforms to job or utility specifications.

Check carefully:

- Main valve size.
- Nozzles and threads.
- Depth of bury.
- Inlet size and type.
- Operating nut size and direction of opening.
- Make sure all nuts and bolts are tight.
- Cycle Hydrant to full-open and close positions.
- Main valve seat for damage and tightness.
- Fully close Hydrant main valve before installation.

STORAGE

In order to ensure the product is protected during storage, please follow these guidelines:

- Care should be taken to observe the positioning of the Hydrants on the skid before attempting to lift or move the palletized Hydrants.

Mueller Co. ships Fire Hydrants on pallets designed specifically for our Hydrants. There are 3 Hydrants to a skid and there are generally 3 skids in a stack for a total of 9 Hydrants. The stack is banded together and banding is tight when

loaded onto trucks at the Mueller Co. facility in Alabama. However, some loosening of the banding can occur as the skids are transported on trucks, trains, barges, ships, etc. Although the Hydrants are placed on the skid so the approximate center of gravity is in the middle of the skid, shifting is possible during shipping.

- While it is not necessary to store the Hydrants in a warehouse, they should be located away from moving vehicles. Not only does

hitting the palletized Hydrant pose a safety risk, but damage to the Hydrant could occur.

- Store Hydrants on the pallets they were shipped on.
- Do not stack Hydrants too high where the stack could become unstable.
- It is recommended to cover the Hydrants to prevent damage to the finish of the Hydrant or the potential for contaminants such as sand to get inside of sealing surfaces.

MUELLER® Centurion® Series Fire Hydrant

Installation

EQUIPMENT & TOOLS NEEDED – PPE: Hard hat, safety shoes, safety vest, safety glasses, work gloves.
Tools: Backhoe, lifting straps.

INSTALLATION

1. Ensure that the Hydrant shoe and main lateral pipe are clean and free of foreign matter before connecting the joint.
2. Install an auxiliary valve (Hydrant shut-off) in the Hydrant lateral.
3. Support Hydrant shoe with firm foundation to prevent settling, using flat stone, cement block or whatever is specified.
4. Set Hydrant plumb.
5. Restrain Hydrant movement with appropriate thrust blocking or approved mechanical restraining method to prevent pipe joint separation.
6. Check drain holes in Hydrant shoe to make sure they are free from obstruction.
7. Provide drain area around Hydrant shoe at a level several inches from the drain holes, using clean, washed stones or coarse gravel. Material should not be smaller than the drain hole diameter or larger than egg-size. Do not use sand.
8. Cover drainage stone with 8-mil polyethylene sheet or similar waterproof material to prevent dirt from clogging the drainage area.
9. Backfill pipe only. Leave Hydrant shoe and auxiliary valve exposed to permit checking for leaks at joints during testing.

Testing

- Close the Hydrant main valve during hydrostatic pressure testing of the system.
- If testing of the Hydrant is required, close the auxiliary valve on the lateral, and pressure test the Hydrant and lateral through a nozzle opening with the main Hydrant valve fully open.
- Allowable leakage of five ounces per minute through the drain holes is permissible, according to AWWA C502 Standard.

Completion

- Backfill and tamp around Hydrant.
- When installing a traffic model Hydrant, make sure that final

grade location is at ground line below the breakable (coupling) flange. If backfill material cannot be compacted sufficiently to support lower standpipe section and prevent shifting from vehicle impact, pour an appropriate concrete pad around the Hydrant.

- Finished surface must be at ground line.
- After final installation is complete, exercise and flush Hydrant to ensure proper operation.

NOTE: Mueller Co. recommends following AWWA M-17 "Manual for Installation, Field Testing and Maintenance of Fire Hydrants."

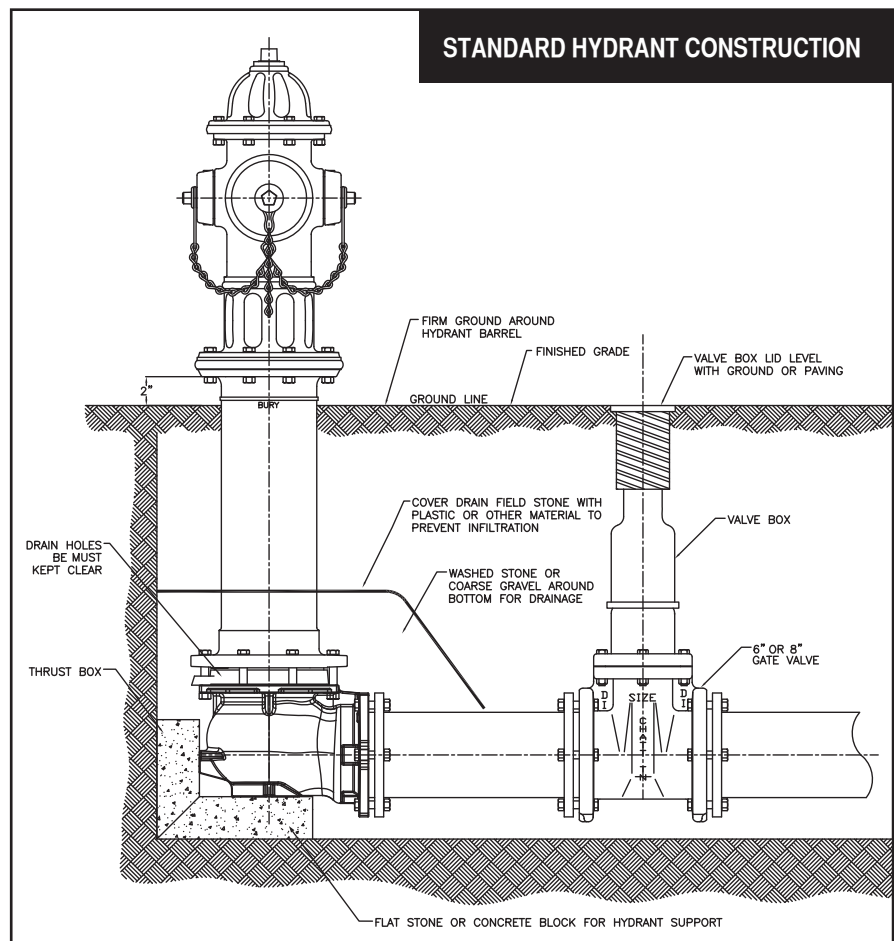

MUELLER® Centurion® Series Fire Hydrant

Facing the Hydrant

 **EQUIPMENT & TOOLS NEEDED – PPE:** Hard hat, safety shoes, safety vest, safety glasses, work gloves.
Tools: A-311 operating wrench and proper bolt/nut wrenches.



1. Loosen Nuts on Safety Flange Bolts.



2. Turn Operating Nut slightly in the opening direction to relieve compression between Barrel sections.



3. Rotate Upper Barrel section as desired.



4. Tighten Operating Nut, turning in closing direction.



5. Tighten Safety Flange Bolts to 60 ft-lbs.



6. Turn Operating Nut in closing direction to make sure Main Valve is closed tightly, then turn in opening direction approximately 1/4 turn to relieve tension on operating mechanism.

MUELLER® Centurion® Series Fire Hydrant

Adding an Extension

⚠ WARNING: Before removing any bolt(s) holding the Hydrant together, shut off gate valve to isolate Hydrant from main water source. Loosen (do not remove) one nozzle cap two turns and check for water under pressure inside Hydrant – bleed off any pressure, then remove nozzle cap completely. Open Hydrant main valve completely. A continuous flow of water, no matter how slight, indicates Hydrant is not properly isolated from the main water supply, and that problem must be corrected before any Hydrant disassembly can proceed. Disassembly of Hydrant with pressurized water acting against the main valve could result in unexpected ejection of Hydrant parts, debris or high-pressure water stream, which could cause serious bodily injury.

🔧 EQUIPMENT & TOOLS NEEDED – PPE: Hard hat, safety shoes, safety vest, safety glasses, work gloves.
Tools: Wrench, A-311 operating wrench, pliers.



1. Remove Hold-Down Nut, Anti-Friction Washer and Operating Nut from Bonnet. Lubricate outside of Brass Sleeve and slide over threaded stem end to prevent O-ring damage. Unbolt Bonnet from Upper Barrel and remove. Remove Brass Sleeve.

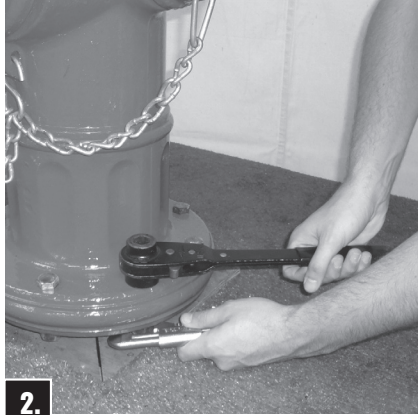

2. Unbolt Safety Flange. Remove Upper Barrel. Remove Upper Stem and Safety Stem Coupling by removing the lower stainless steel Cotter Pin and stainless steel Clevis Pin.



3. Place Extension Stem and Extension Coupling on Lower Stem and retain it with stainless steel Clevis Pin and stainless steel Cotter Pin.



4. Attach Extension Barrel to Lower Barrel with solid Flange halves (without groove) and Bolts, being sure O-ring is in place.

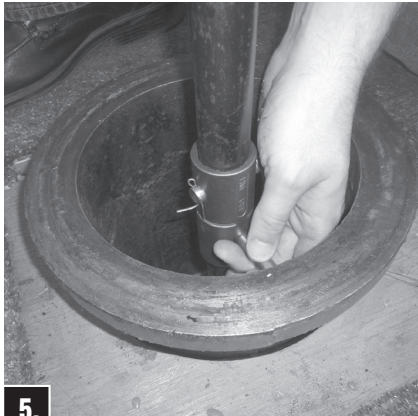

5. Assemble Upper Stem and Safety Stem Coupling onto Extension Stem and retain it with stainless steel Clevis Pin and stainless steel Cotter Pin.

NOTE: Make sure Safety Stem Coupling is installed with “This End Up” towards the Upper Stem.

MUELLER® Centurion® Series Fire Hydrant

Adding an Extension

⚠ CAUTION: Always fill the oil reservoir with the Bonnet installed, the Hydrant in its normal upright position, and the main valve fully closed. If the Hydrant is filled with lubricant under any other circumstances, excess lubricate can overflow the Bonnet and create a pressure lock. This could result in damage to the seals or Bonnet or prevent proper Hydrant operation.

🔧 EQUIPMENT & TOOLS NEEDED – PPE: Hard hat, safety shoes, safety vest, safety glasses, work gloves.
Tools: Wrenches, A-311 operating wrench.

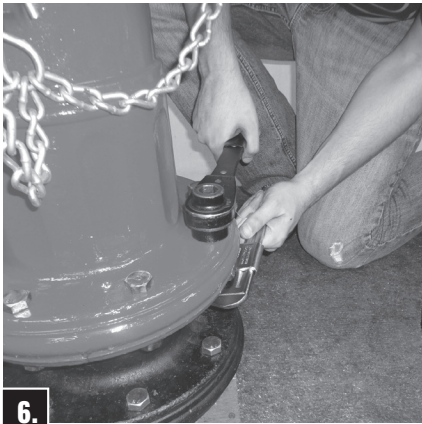

6. Attach Upper Barrel with Safety Flange Halves (with bevel on outer edge downward) and Bolts; being sure Safety Flange O-ring* is in groove in Upper Barrel. Tighten Bolts to 60 ft-lbs.

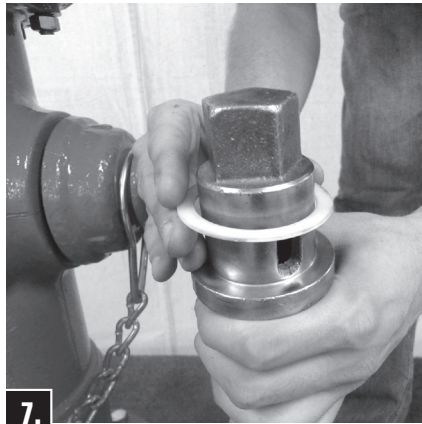

7. Check Bonnet O-ring* for proper position and condition. Attach Brass Sleeve to Upper Stem and lubricate outside to protect O-ring Seals from thread damage. Place Bonnet onto Upper Barrel and assemble Bonnet Bolts only hand-tight. Remove Brass Sleeve. Reassemble Operating Nut, Anti-Friction Washer, and Hold-Down Nut (snug-tighten). Be sure O-ring Seals are in good condition at thread shoulder on outside of Hold-Down Nut and on inside where contact is made with Operating Nut.



8. Remove Oil Filler Plug in side of Bonnet. Pour MUELLER Hydrant Lubricant into Oil Reservoir until it is level with Oil Filler Plug Hole. Replace Oil Filler Plug (see Lubrication section on page 8).

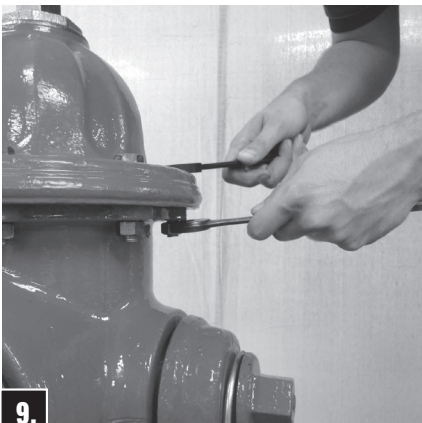

9. Torque Bonnet Bolts to 40-80 ft-lbs. Torque Hold-Down Nut to 200-300 ft-lbs. after Bonnet Bolts are tight. Open Gate Valve. Unscrew one Hose Nozzle Cap slightly to bleed air. Open Hydrant fully. Tighten Hose Nozzle Cap when water starts flowing and check all flange connections for leaks. Turn Operating Nut to fully closed position and remove Hose Nozzle Cap to allow Barrel to drain. Replace Hose Nozzle Cap.

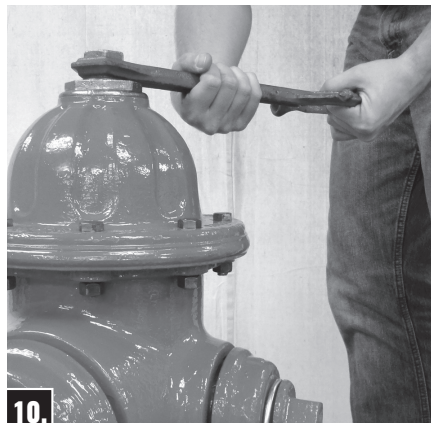

10. Turn Operating Nut in closing direction to make sure Main Valve is closed tightly, then turn in opening direction approximately 1/4 turn to relieve tension on operating mechanism.

*To determine correct O-rings for Bonnet and Ground Line flanges, which are similar in appearance: smaller diameter O-ring is used at Bonnet flange; larger at Ground line flange.

MUELLER® Centurion® Series Fire Hydrant

Lubrication and Maintenance

⚠ CAUTION: Always fill the oil reservoir with the Bonnet installed, the Hydrant in its normal upright position, and the main valve fully closed. If the Hydrant is filled with lubricant under any other circumstances, excess lubricant can overflow the Bonnet and create a pressure lock. This could result in damage to the seals or Bonnet or prevent proper Hydrant operation.

🔧 EQUIPMENT & TOOLS NEEDED – PPE: Safety shoes, safety vest, safety glasses, work gloves.
Tools: 1/4" hex-head wrench, A-51 lubricating oil, A-311 operating wrench, A-367 brass sleeve.

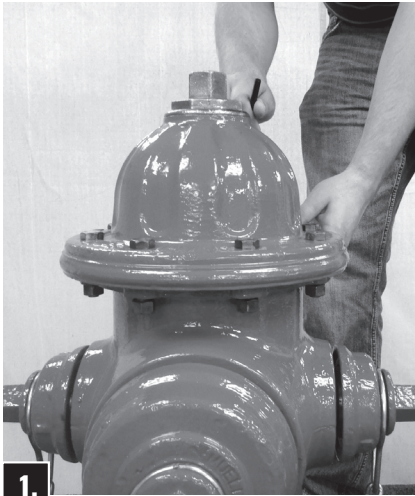

Remove Oil Filler Plug and check oil level. Oil should be level with Oil Filler Plug Hole.



If oil is low, use a small funnel to add MUELLER Hydrant Lubricant.



When oil is level with Oil filler Plug Hole, replace Oil Filler Plug.

MAINTENANCE

1. To ensure their readiness for immediate use, it is recommended that Fire Hydrants be inspected and tested at six-month intervals.

2. Inspect visually for damaged or missing parts.

3. Remove Oil Filler Plug to check oil level. If oil level is low, fill as shown above. Loosen one Nozzle Cap slightly and tighten the others. Open Hydrant fully. Tighten loose Nozzle Cap when water starts to flow. Check all flange connections for leaks. Turn Operating Nut to fully CLOSED position.

4. If water or oil overflows from Oil Filler Hole, remove Bonnet and replace O-rings in both the Bonnet and the Hold-Down Nut. Inspect and clean Stem, and replace it if corroded or pitted. Check oil level. Replace Bonnet and test for leaks.

5. Use A-367 Brass Sleeve when removing or replacing Bonnet or Hydrant Barrel to protect stem O-rings.

6. Remove one Nozzle Cap, stand on the side of Hydrant opposite the cap removed, open Hydrant fully, and flush Barrel and Hydrant Lateral. Turn Operating Nut to fully CLOSED position.

7. Remove all Nozzle Caps. Clean and lubricate threads.

8. Examine inside of Barrel to make certain Drain Valves have completely drained water from Barrel. If water fails to drain from Barrel, it may be caused by one or more of the following conditions:

- Water Table in ground is higher than Drains.
- When Hydrant was installed, coarse gravel was not placed around Drains.

- Drains are clogged by some foreign material.
- Failure to leave Cap off of Hydrant to allow air to enter so Barrel will drain.

The foregoing procedure introduces full line pressure to Drain Valves. It provides the best method for cleaning Drain Valves using water pressure.

⚠ IMPORTANT - Initial installation of Hydrant MUST BE MADE PROPERLY so Safety Flange will function properly. Hydrant should be blocked at ground line and around Shoe using concrete or similar substance to prevent ground from giving way when Hydrant is struck (see page 9-10).

For additional information on Hydrant anchorage, blocking, and drainage, see AWWA Standard C600 and Manual M17.

MUELLER® Centurion® Series Fire Hydrant

Restoring Service after Traffic Knockover

⚠ WARNING: Before removing any bolt(s) holding the Hydrant together, shut off gate valve to isolate Hydrant from main water source. Loosen (do not remove) one nozzle cap two turns and check for water under pressure inside Hydrant – bleed off any pressure, then remove nozzle cap completely. Open Hydrant main valve completely. A continuous flow of water, no matter how slight, indicates Hydrant is not properly isolated from the main water supply, and that problem must be corrected before any Hydrant disassembly can proceed. Disassembly of Hydrant with pressurized water acting against the main valve could result in unexpected ejection of Hydrant parts, debris or high-pressure water stream, which could cause serious bodily injury.

🔧 EQUIPMENT & TOOLS NEEDED – PPE: Hard hat, safety shoes, safety vest, safety glasses, work gloves.
Tools: Wrench, A-311 operating wrench.

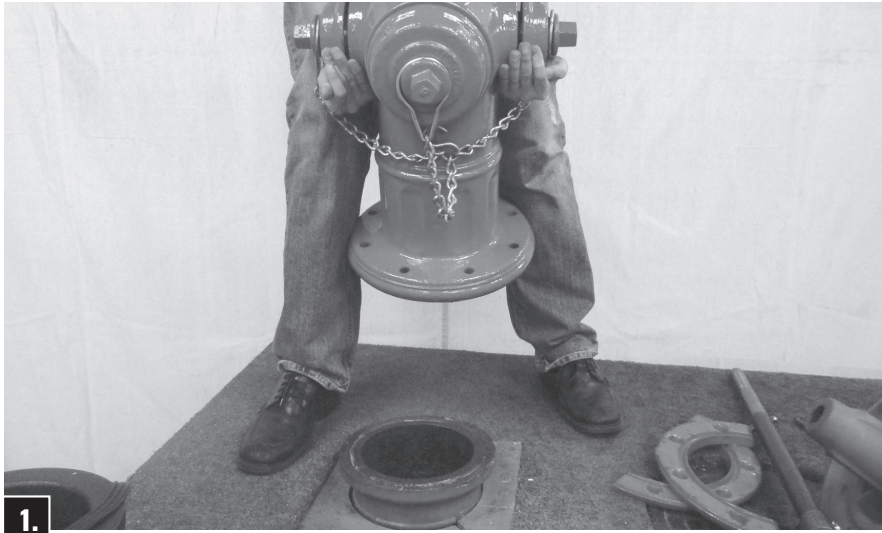

1.

Remove stainless steel Cotter Pin from stainless steel Clevis Pin. Remove Clevis Pin and Safety Coupling from Upper Stem. Unbolt and remove broken Safety Flange from Upper Barrel. Remove Hold-Down Nut, Anti-Friction Washer, and Operating Nut from Bonnet. Lubricate Brass Sleeve and slide over threaded Stem end to prevent O-ring damage. Unbolt Bonnet from Upper Barrel. Slide Upper Stem out of Bonnet and remove Brass Sleeve.

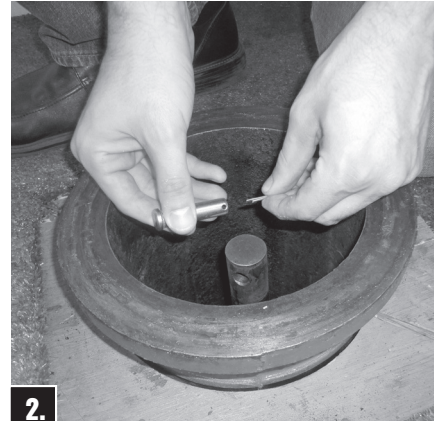

2.

Remove stainless steel Cotter Pin from stainless steel Clevis Pin in Lower Stem (throw away the old Clevis Pin, Cotter Pin, and old coupling).



3.

Assemble new Safety Stem Coupling to Upper Stem with new stainless steel Clevis Pin and new stainless steel Cotter Pin.

NOTE: "This End Up" Molded on Coupling.

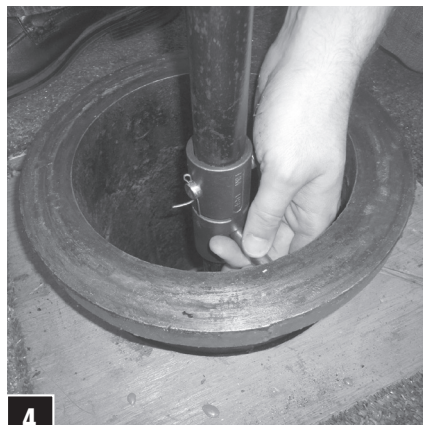

4.

Assemble Upper Stem and new Safety Stem Coupling onto Lower Stem and retain it with the new stainless steel Clevis Pin and new stainless steel Cotter Pin furnished with Safety Stem Coupling.

MUELLER® Centurion® Series Fire Hydrant

Restoring Service after Traffic Knockover

⚠ CAUTION: Always fill the oil reservoir with the Bonnet installed, the Hydrant in its normal upright position, and the main valve fully closed. If the Hydrant is filled with lubricant under any other circumstances, excess lubricate can overflow the Bonnet and create a pressure lock. This could result in damage to the seals or Bonnet or prevent proper Hydrant operation.

🔧 EQUIPMENT & TOOLS NEEDED – PPE: Hard hat, safety shoes, safety vest, safety glasses, work gloves.
Tools: Wrenches, A-311 operating wrench.



5. Attach Upper Barrel with new Safety Flange Halves (with bevel on outer edge downward) and Bolts; being sure Safety Flange O-ring* is in groove in Upper Barrel. Tighten Bolts to 60 ft-lbs.



6. Check Bonnet O-ring* for proper position and condition. Attach Brass Sleeve to Upper Stem and lubricate outside to protect O-ring Seals from thread damage. Place Bonnet onto Upper Barrel and assemble Bonnet Bolts only hand-tight. Remove Brass Sleeve. Reassemble Operating Nut, Anti-Friction Washer, and Hold-Down Nut (snug-tighten). Be sure O-ring Seals are in good condition at thread shoulder on outside of Hold-Down Nut and on inside where contact is made with Operating Nut.



7. Remove Oil Filler Plug in side of Bonnet. Pour MUELLER Hydrant Lubricant into Oil Reservoir until it is level with Oil Filler Plug Hole. Replace Oil Filler Plug (see Lubrication section on page 8).

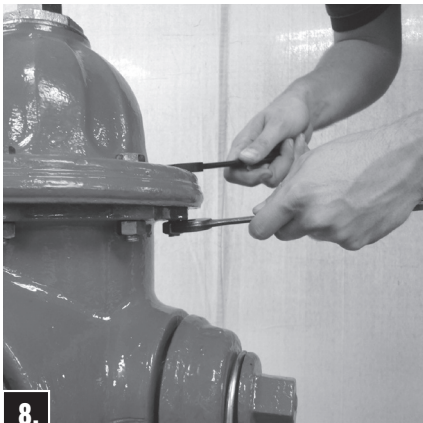

8. Torque Bonnet Bolts to 40-80 ft-lbs. Torque Hold-Down Nut to 200-300 ft-lbs. after Bonnet Bolts are tight. Open Gate Valve. Unscrew one Hose Nozzle Cap slightly to bleed air. Open Hydrant fully. Tighten Hose Nozzle Cap when water starts flowing and check all flange connections for leaks. Turn Operating Nut to fully closed position and remove Hose Nozzle Cap to allow Barrel to drain. Replace Hose Nozzle Cap.



9. Turn Operating Nut in closing direction to make sure Main Valve is closed tightly, then turn in opening direction approximately 1/4 turn to relieve tension on operating mechanism.

*To determine correct O-rings for Bonnet and Ground Line flanges, which are similar in appearance: smaller diameter O-ring is used at Bonnet flange; larger at Ground line flange.

MUELLER® Centurion® Series Fire Hydrant

Main Valve Replacement: Bonnet Flange

⚠ WARNING: Before removing any bolt(s) holding the Hydrant together, shut off gate valve to isolate Hydrant from main water source. Loosen (do not remove) one nozzle cap two turns and check for water under pressure inside Hydrant – bleed off any pressure, then remove nozzle cap completely. Open Hydrant main valve completely. A continuous flow of water, no matter how slight, indicates Hydrant is not properly isolated from the main water supply, and that problem must be corrected before any Hydrant disassembly can proceed. Disassembly of Hydrant with pressurized water acting against the main valve could result in unexpected ejection of Hydrant parts, debris or high-pressure water stream, which could cause serious bodily injury.

🔧 EQUIPMENT & TOOLS NEEDED – PPE: Hard hat, safety shoes, safety vest, safety glasses, work gloves.
Tools: Wrench, A-367 brass sleeve, A-359 seat wrench, A-311 operating wrench.



1. Remove Hold-Down Nut Operating Nut and Anti-Friction Washer from Bonnet. Lubricate Brass Sleeve and slide over threaded stem to prevent O-ring damage. Unbolt and remove Bonnet. Remove Brass Sleeve.

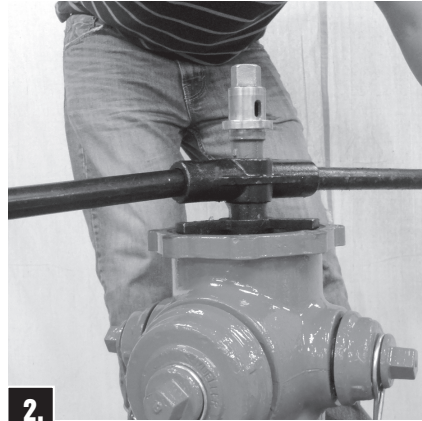

2. Slide slotted end of Wrench over top of Stem and engage the slot with Pin in Upper Stem. Thread Operating Nut onto stem and tighten against wrench to hold it securely. Pull up on A-359 to be sure the main valve is completely closed. Lower support arm onto top flange of the Upper Barrel and tighten Thumb Screw to hold the Main Valve in the closed position. Remove Main Valve Assembly by turning Seat Wrench counter-clockwise.

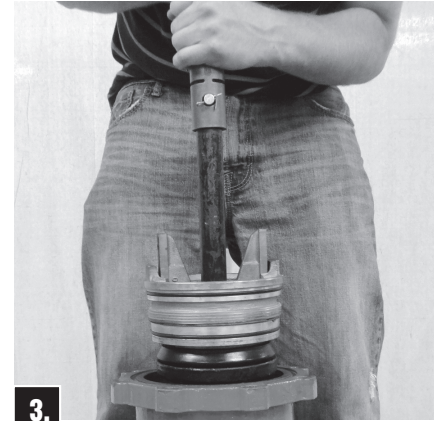

3. Lift out Wrench, Lower Stem, Main Valve Assembly and Seat Ring from Hydrant Barrel as a unit.

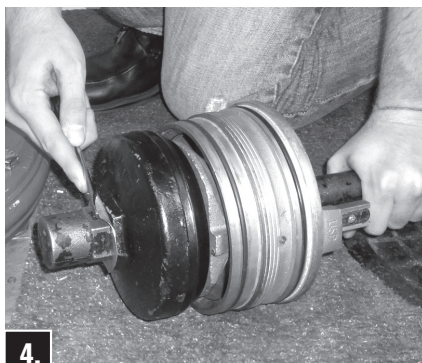

4. Straighten stainless steel Lock Washer, unscrew Cap Nut and remove Washer, Stem Seal, Lower Valve Plate, Main Valve and Seat Ring. Clean, inspect and replace any damaged parts. (Super Centurion 250 Main Valve can be reversed to provide new seal.) Replace Drain Ring Facings. Inspect and lubricate Top and Bottom Seat Ring O-rings (replace if necessary). Lubricate all threaded surfaces and reassemble. With Cap Nut tightened to 100 ft-lbs, bend edges of stainless steel Lock Washer over one flat on the Lower Valve Plate and one flat on the Cap Nut.



5. Lower Main Valve into the Barrel. Lower Support Arm and tighten Thumb Screw. Carefully thread main valve assembly clockwise into the base of the Hydrant. Hand tighten.

MUELLER® Centurion® Series Fire Hydrant

Main Valve Replacement: Bonnet Flange

⚠ CAUTION: Always fill the oil reservoir with the Bonnet installed, the Hydrant in its normal upright position, and the main valve fully closed. If the Hydrant is filled with lubricant under any other circumstances, excess lubricant can overflow the Bonnet and create a pressure lock. This could result in damage to the seals or Bonnet or prevent proper Hydrant operation.

🔧 EQUIPMENT & TOOLS NEEDED – PPE: Hard hat, safety shoes, safety vest, safety glasses, work gloves.
Tools: Wrench, A-367 brass sleeve, A-359 seat wrench, A-311 operating wrench.



6.

Tighten Main Valve to 100-150 ft-lbs. Turn on water at the Gate Valve and remove Wrench from Stem by removing Clevis Pin.



7.

Check Bonnet O-ring* for proper position and condition. Attach Brass Sleeve to Upper Stem and lubricate outside to protect O-ring Seals from thread damage. Place Bonnet onto Upper Barrel and assemble Bonnet Bolts only hand-tight. Remove Brass Sleeve. Reassemble Operating Nut, Anti-Friction Washer, and Hold-Down Nut (snug-tighten). Be sure O-ring Seals are in good condition at thread shoulder on outside of Hold-Down Nut and on inside where contact is made with Operating Nut.



8.

Remove Oil Filler Plug in side of Bonnet. Pour MUELLER Hydrant Lubricant into Oil Reservoir until it is level with Oil Filler Plug Hole. Replace Oil Filler Plug (see Lubrication section on page 8).

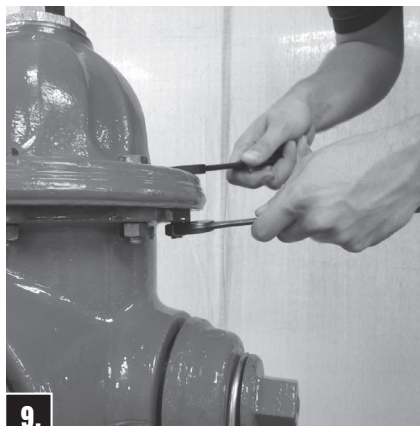

9.

Torque Bonnet Bolts to 40-80 ft-lbs. Torque Hold-Down Nut to 200-300 ft-lbs. after Bonnet Bolts are tight. Open Gate Valve. Unscrew one Hose Nozzle Cap slightly to bleed air. Open Hydrant fully. Tighten Hose Nozzle Cap when water starts flowing and check all flange connections for leaks. Turn Operating Nut to fully closed position and remove Hose Nozzle Cap to allow Barrel to drain. Replace Hose Nozzle Cap.



10.

Turn Operating Nut in closing direction to make sure Main Valve is closed tightly, then turn in opening direction approximately 1/4 turn to relieve tension on operating mechanism.

*To determine correct O-rings for Bonnet and Ground Line flanges, which are similar in appearance: smaller diameter O-ring is used at Bonnet flange; larger at Ground line flange.

MUELLER® Centurion® Series Fire Hydrant

Main Valve Replacement: Lower Barrel Flange

⚠ WARNING: Before removing any bolt(s) holding the Hydrant together, shut off gate valve to isolate Hydrant from main water source. Loosen (do not remove) one nozzle cap two turns and check for water under pressure inside Hydrant – bleed off any pressure, then remove nozzle cap completely. Open Hydrant main valve completely. A continuous flow of water, no matter how slight, indicates Hydrant is not properly isolated from the main water supply, and that problem must be corrected before any Hydrant disassembly can proceed. Disassembly of Hydrant with pressurized water acting against the main valve could result in unexpected ejection of Hydrant parts, debris or high-pressure water stream, which could cause serious bodily injury.

🔧 EQUIPMENT & TOOLS NEEDED – PPE: Hard hat, safety shoes, safety vest, safety glasses, work gloves.
Tools: Wrench, A-367 brass sleeve, A-359 seat wrench, A-311 operating wrench.



1.

Remove Hold-Down Nut, Anti-Friction Washer and Operating Nut from Bonnet. Lubricate Brass Sleeve and slide over threaded stem end to prevent O-ring damage.

Unbolt and remove Bonnet. Remove Safety Flange Bolts and Safety Flange. Remove Upper Barrel.

Remove Upper Stem and Stem Coupling from Lower Stem.



2.

Slide slotted end of Wrench over Lower Stem. Align holes in Wrench and Stem and attach Wrench to Stem with Clevis Pin. Lower Support Arm onto the Flange of Lower Barrel and tighten Thumb Screw (to hold Main Valve in closed position). Remove Main Valve Assembly by turning Wrench counter-clockwise and lift out Wrench, Lower Stem, Main Valve Assembly and Seat Ring from Hydrant Barrel as a unit.

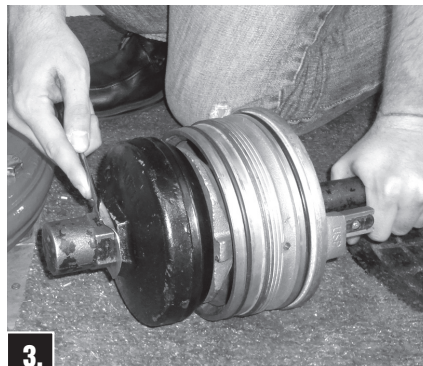

3.

Straighten stainless steel Lock Washer, unscrew Cap Nut and remove Washer, Stem Seal, Lower Valve Plate, Main Valve and Seat Ring. Clean, inspect and replace any damaged parts. (Super Centurion 250 Hydrant Main Valve can be reversed to provide new seal.) Replace Drain Valve Facings. Inspect and lubricate Top and Bottom Seat Ring O-rings (replace if necessary). Lubricate all threaded surfaces and reassemble. With Cap Nut tightened to 100 ft-lbs, bend edges on stainless steel Lock Washer over one flat on the Lower Valve Plate and one flat on the Cap Nut.



4.

Lower Main Valve into the Barrel. Lower Support Arm and tighten Thumb Screw. Carefully thread main valve assembly clockwise into the base of the Hydrant. Hand tighten.

MUELLER® Centurion® Series Fire Hydrant

Main Valve Replacement: Lower Bonnet Flange

⚠ CAUTION: Always fill the oil reservoir with the Bonnet installed, the Hydrant in its normal upright position, and the main valve fully closed. If the Hydrant is filled with lubricant under any other circumstances, excess lubricant can overflow the Bonnet and create a pressure lock. This could result in damage to the seals or Bonnet or prevent proper Hydrant operation.

🔧 EQUIPMENT & TOOLS NEEDED – PPE: Hard hat, safety shoes, safety vest, safety glasses, work gloves.
Tools: Wrench, A-367 brass sleeve, A-359 seat wrench, A-311 operating wrench.



5. Tighten Main Valve to 100-150 ft-lbs. Turn on water at the Gate Valve and remove Wrench from Stem by removing Clevis Pin.



6. Reassemble Upper Stem to Lower Stem. Place Upper Barrel in place and reassemble Safety Flange.* Tighten Bolts to 60 ft-lbs.



7. Check Bonnet O-ring* for proper position and condition. Attach Brass Sleeve to Upper Stem and lubricate outside to protect O-ring Seals from thread damage. Place Bonnet onto Upper Barrel and assemble Bonnet Bolts only hand-tight. Remove Brass Sleeve. Reassemble Operating Nut, Anti-Friction Washer, and Hold-Down Nut (snug-tighten). Be sure O-ring Seals are in good condition at thread shoulder on outside of Hold-Down Nut and on inside where contact is made with Operating Nut.



8. Remove Oil Filler Plug in side of Bonnet. Pour MUELLER Hydrant Lubricant into Oil Reservoir until it is level with Oil Filler Plug Hole. Replace Oil Filler Plug (see Lubrication section on page 8).

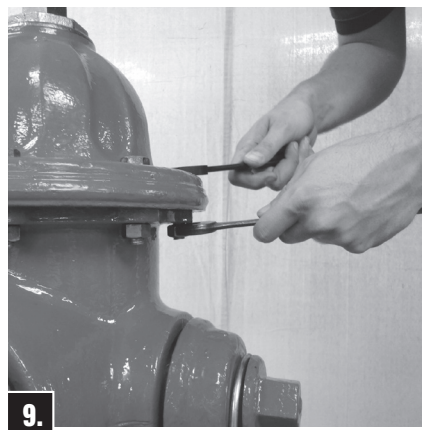

9. Torque Bonnet Bolts to 40-80 ft-lbs. Torque Hold-Down Nut to 200-300 ft-lbs. after Bonnet Bolts are tight. Open Gate Valve. Unscrew one Hose Nozzle Cap slightly to bleed air. Open Hydrant fully. Tighten Hose Nozzle Cap when water starts flowing and check all flange connections for leaks. Turn Operating Nut to fully closed position and remove Hose Nozzle Cap to allow Barrel to drain. Replace Hose Nozzle Cap.



10. Turn Operating Nut in closing direction to make sure Main Valve is closed tightly, then turn in opening direction approximately 1/4 turn to relieve tension on operating mechanism.

*To determine correct O-rings for Bonnet and Ground Line flanges, which are similar in appearance: smaller diameter O-ring is used at Bonnet flange; larger at Ground line flange.

MUELLER® Centurion® Series Fire Hydrant

Replacing Damaged Nozzles

 **EQUIPMENT & TOOLS NEEDED – PPE:** Hard hat, safety shoes, safety vest, safety glasses, work gloves.
Tools: Wrench, A-316 nozzle wrench, brass hammer.



1. Remove Nozzle Cap.



2. Remove stainless steel Nozzle Lock by driving it out with a pointed tool and hammer.



3. Place Nozzle Wrench, A-316, on Nozzle with Wrench Forks facing toward Hydrant Barrel and locked onto Nozzle Drive Lugs. Replace Nozzle Cap and tighten until Cap rests loosely against backside of Wrench. Remove Nozzle (nozzle threads out in a clockwise rotation). Additional leverage may be obtained by placing a length of 2" schedule 40 steel pipe over the handle of the Nozzle Wrench.

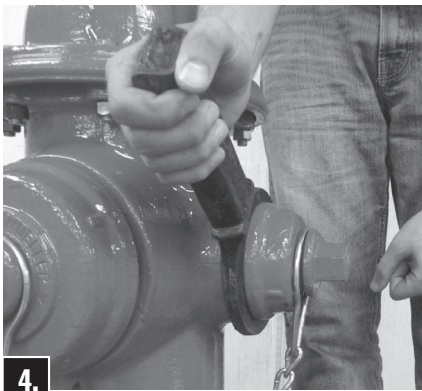

4. Install Nozzle O-ring on the inlet side of the nozzle. Thread new Nozzle into Upper Barrel, attach A-316 Nozzle Wrench as described in Step 3, and tighten Nozzle (nozzle threads in a clockwise rotation) to approximately 600 ft-lbs torque (100 lbs. pull on a 6' lever).



5. Remove Nozzle Cap and A-316 Nozzle Wrench. Place the Nozzle Lock (Part 143137), lengthwise in the slot formed by the Nozzle Drive Lugs and the Barrel Bore. Drive the Nozzle Lock in place by striking the Nozzle Lock Installation Tool (Part 143132) several times with a heavy brass hammer.

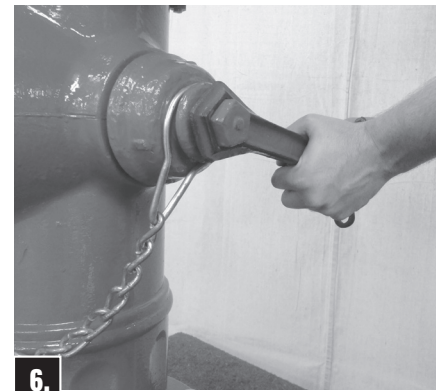

6. Replace and tighten Nozzle Cap.

 **CAUTION:** Wear safety glasses when using a striking tool. The Nozzle Lock does not have to be completely seated into the slot, but it should be well engaged along the entire length of the Nozzle Drive Lug and Barrel Bore.

MUELLER® Centurion® Series Fire Hydrant

Changing the Shoe

 **EQUIPMENT & TOOLS NEEDED** – PPE: Hard hat, safety shoes, safety vest, safety glasses, work gloves.
Tools: Wrench, A-316 nozzle wrench.

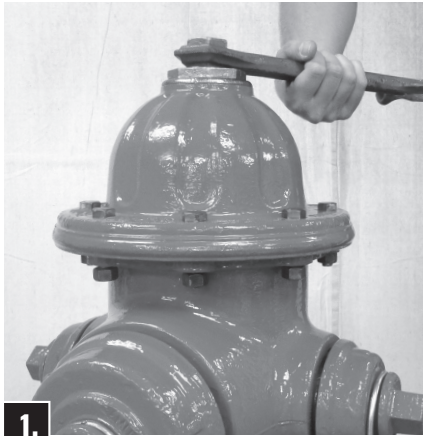

1. Tighten Operating Nut to be sure Main Valve is in the fully closed position.



2. Remove all 6 Shoe Bolt Nuts.



3. Slip off Hydrant Shoe.

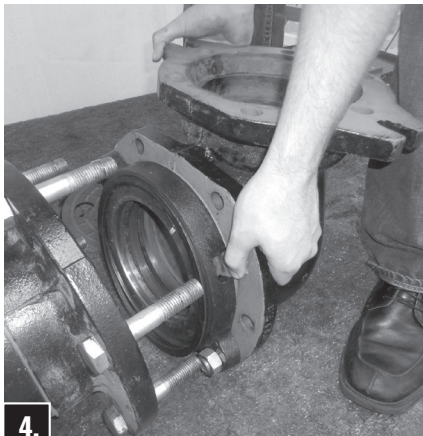

4. Lubricate new Shoe and Bottom Seat Ring O-ring. Position Shoe to slip in place.



5. Slip new Shoe in place being careful not to damage Bottom Seat Ring O-ring.

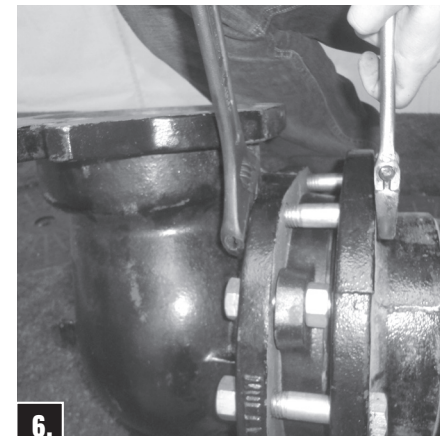

6. Replace Shoe Bolts and Nuts and tighten to 100 ft-lbs.

Preparation and Instructions

Top Coat Repair

All shoes, lower and upper barrels, Bonnets and hose caps are **primer coated** inside and outside with epoxy. Exposed portions of the Hydrant including the exterior of the Bonnet, upper barrel and hose caps are **top coated** with Polyurethane enamel paint.

While precautions are taken to protect Hydrants during transit, top coat repair is sometimes necessary

due to damage from transportation and handling. Hydrants may also require re-coating after extended periods of exposure to prevailing environmental conditions.

Recoating and touch-up require the same process.

Repainting

1. Thoroughly clean the Hydrant – wash off any dirt or loose debris.

2. Remove surface rust – by wire brushing, sandblasting, etc.

3. Roughen shiny surfaces – with light sanding (to improve paint adhesion).

4. Primer coat bare metal – spot prime.

5. Apply top coat – top coat with a polyurethane compatible coating.

MUELLER® Centurion® Series Fire Hydrant

Super Centurion® 200 and 250 Parts

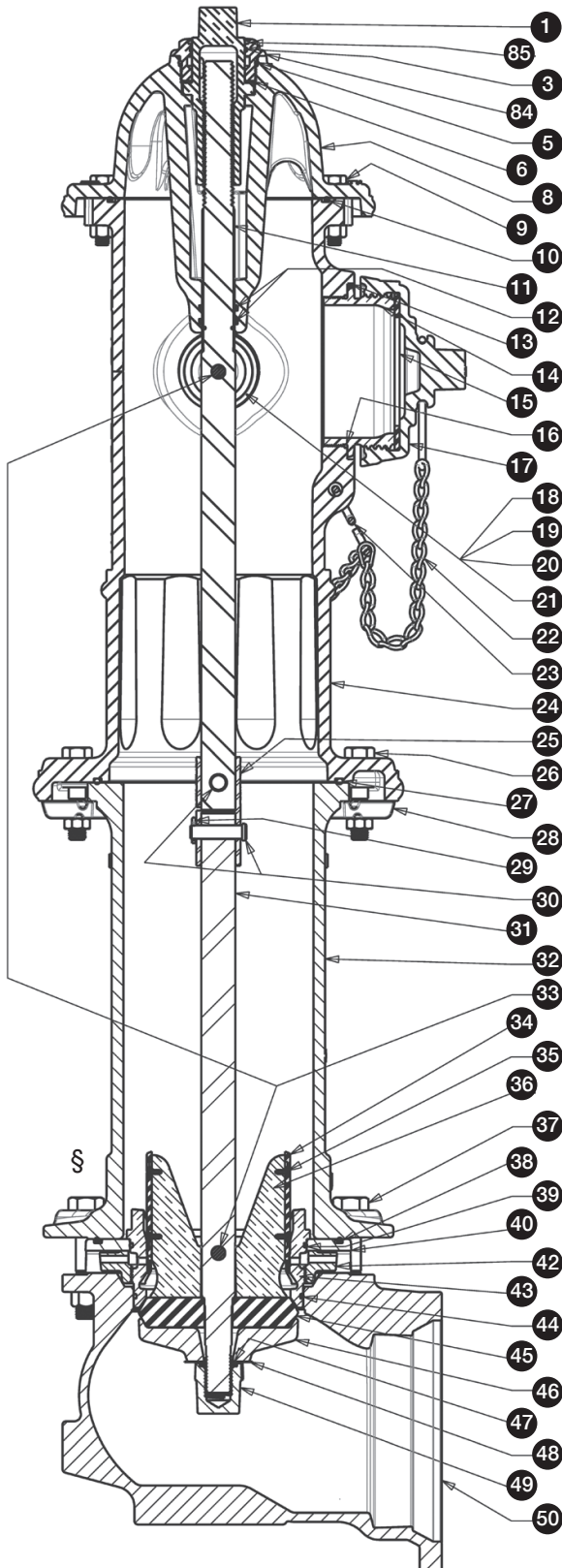

- A-1 Operating Nut
- A-85 Weather Seal ¹
- A-3 Hold-Down Nut O-ring ¹
- A-84 Hold Down Nut
- A-5 Bonnet O-ring ¹
- A-6 Anti-Friction Washer ¹
- A-7 Oil Filler Plug
- A-8 Bonnet
- A-9 Bonnet Bolt & Nut
- A-10 Bonnet Flange O-ring ^{1, 4}
- A-11 Upper Stem
- A-12 Stem O-ring ¹
- A-13 Nozzle Locks (Pumper & Hose)
- A-14 Pumper Nozzle
- A-15 Pumper Nozzle Gasket
- A-16 Pumper Nozzle O-ring
- A-17 Pumper Nozzle Cap
- A-18 Hose Nozzle
- A-19 Hose Nozzle Gasket
- A-20 Hose Nozzle O-ring
- A-21 Hose Nozzle Cap
- A-22 Cap Chain
- A-23 Chain Ring
- A-24 Upper Barrel
- A-25 Safety Stem Coupling ⁴
- A-26 Safety Flange Bolt & Nut ⁴
- A-27 Safety Flange O-ring ⁴
- A-28 Safety Flange ⁴
- A-29 Cotter Pin ⁴
- A-30 Clevis Pin ⁴
- A-31 Lower Stem
- A-32 Lower Barrel
- A-33 Stem Pin
- A-34 Drain Valve Facing ²
- A-35 Drain Valve Facing Screw ²
- A-36 Upper Valve Plate
- A-37 Shoe Bolt & Nut ²
- A-38 Drain Ring Housing O-ring ²
- A-39 Top Seat Ring O-ring ^{2, 3}
- A-40 Drain Ring Housing
- A-42 Drain Ring
- A-43 Seat Ring ³
- A-44 Bottom Seat Ring O-ring ^{2, 3}
- A-45 Main Valve ^{2, 3, 5}
- A-46 Lower Valve Plate ^{2, 3, 5}
- A-47 Cap Nut Seal ^{2, 3}
- A-48 Lock Washer ²
- A-49 Lower Valve Plate Nut
- A-50 Shoe

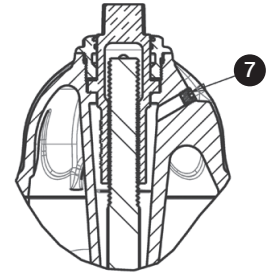

- 1. Available as part of Bonnet Repair Kit
- 2. Available as part of Shoe Repair Kit
- 3. Available as part of Main Valve Repair Kit
- 4. Available as part of Safety Flange Repair Kit
- 5. Reversible Main Valve pictured

MUELLER® Centurion® Series Fire Hydrant

Tools



A-316 Nozzle Wrench



A-359 Seat Wrench

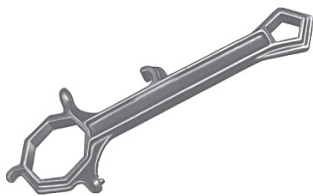

A-311 Operating Wrench

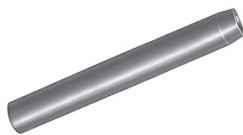

A-367 Brass Sleeve



Reliable Connections

Water (U.S.)
1.800.423.1323
www.muellercompany.com
moreinfo@muellercompany.com

Water (Canada)
1.705.719.9965
www.muellercanada.com
more-info@muellercanada.com

International
1.423.490.9555
www.mueller-international.com
international@muellercompany.com

Copyright © 2016 Mueller Co., LLC. All Rights Reserved.

The trademarks, logos and service marks displayed in this document herein are the property of Mueller Co., LLC, its affiliates or other third parties. Products above marked with a section symbol (§) are subject to patents or patent applications. For details, visit www.mwppat.com. These products are intended for use in potable water applications. Please contact your Mueller Sales or Customer Service Representative concerning any other application(s).

Form 11929 - 05/16